



Revision: 01-03-20

Versus-omega preserves the right to alter parts and drawings at all times. Check online for the most recent updated versions.



 : PENTA WAVE SRL

# Vs



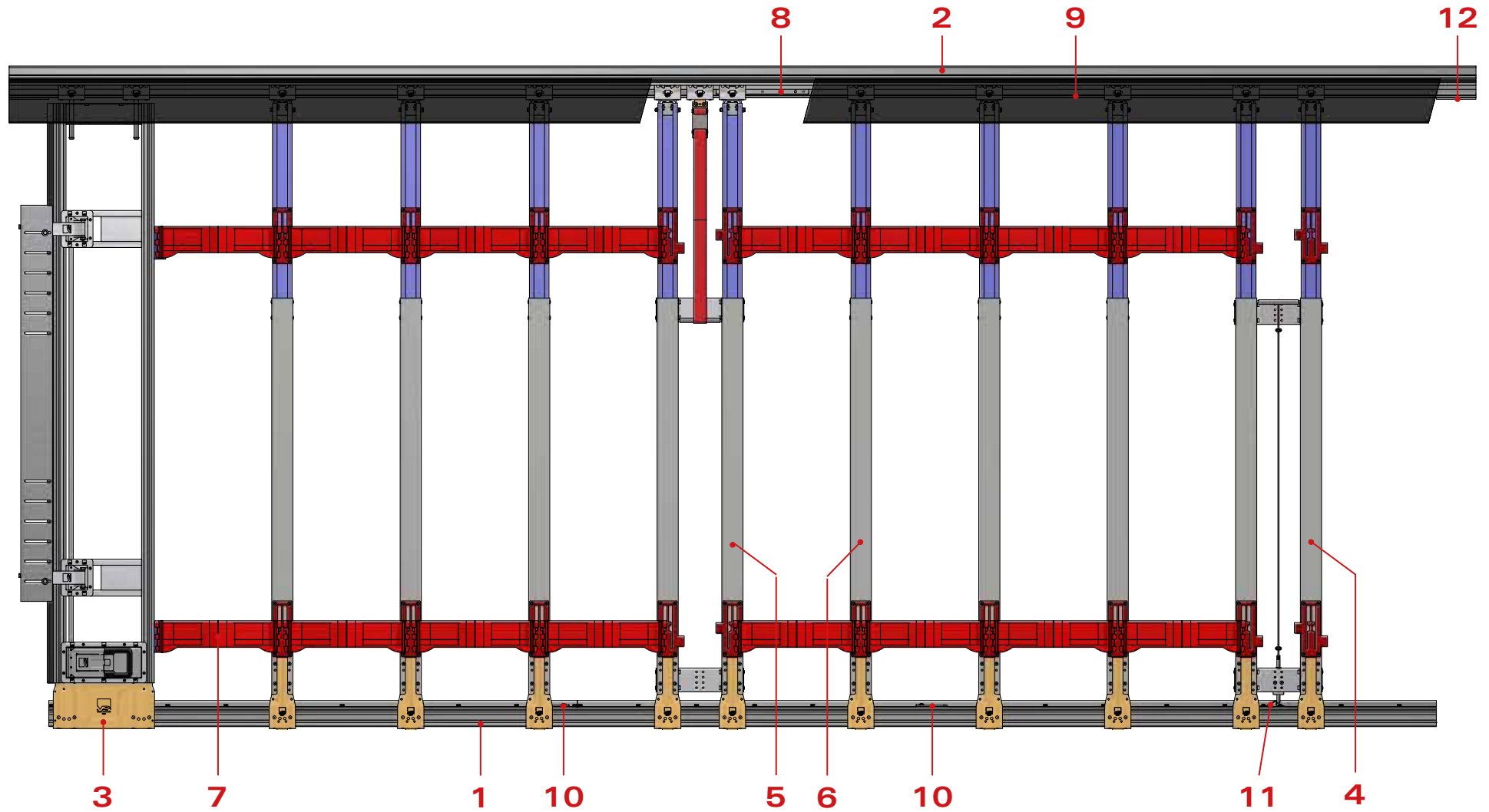

1	Penta Wave rail (RVS)
2	Duo Penta rail (Al)
3	Quick lock door
4	Basic door
5	Pillar
6	Mini pillar
7	Folding plate

8	Set steel insert
9	PVC pelmet
10	Set door stopper
11	Set locking nose
12	Set mounting plates
13*	Set fixation curtain

\* Not visible on the composition drawing above.

### 3 Quick lock door

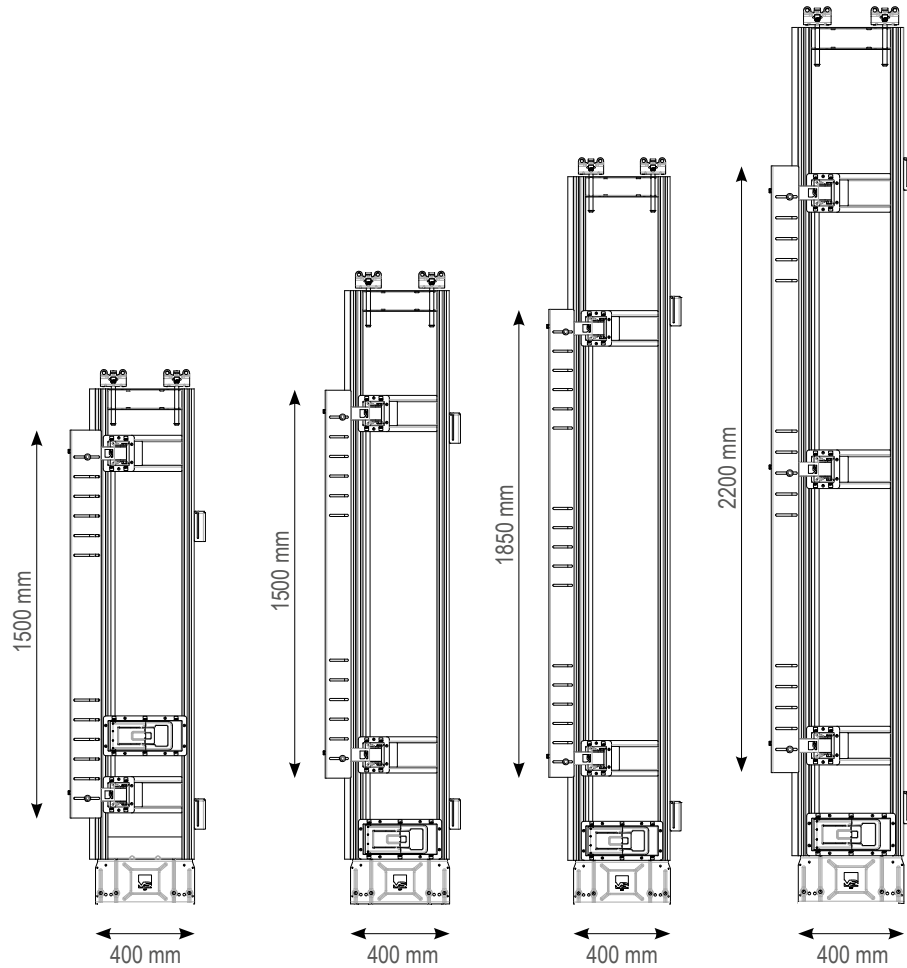

**PART NR.**      **PART NR.**      **PART NR.**      **PART NR.**

Left SA	624-01212	624-01200	624-01201	624-01202
Right SA	624-01213	624-01203	624-01204	624-01205
Left LA	624-01214	624-01206	624-01207	624-01208
Right LA	624-01215	624-01209	624-01210	624-01211

Extra Small 1920-2170mm      Small 2171-2420mm      Medium 2421-2800mm      Large 2801 -2950mm

Small arm (SA) = short hinge arm covering distance of 40 to 103mm  
Large arm (LA) = long hinge arm covering distance of 103 to 190mm

### 4 Basic door

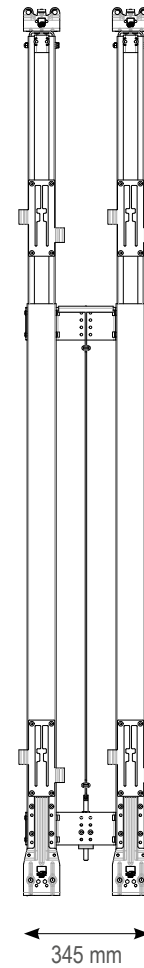

**PART NR.**

XS	624-03223
S	624-03220
M	624-03221
L	624-03222

### 5 Pillar

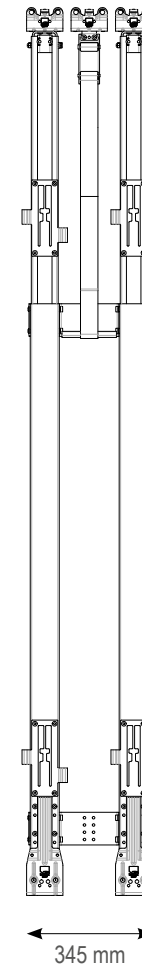

**PART NR.**

XS	624-02227
S	624-02220
M	624-02221
L	624-02222

### 6 Mini pillar

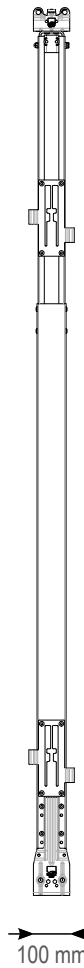

**PART NR.**

XS	624-04223
S	624-04220
M	624-04221
L	624-04222

Extra Small (XS) = aperture height between 1920 and 2170mm  
Small (S) = aperture height between 2171 and 2420mm  
Medium (M) = aperture height between 2421 and 2700mm  
Large (L) = aperture height between 2701 and 2950mm

**1 Penta Wave rail (RVS)**

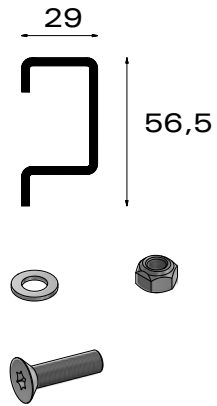

**PART NR.**

Rail L = 3m	162-44304
Set (1/rail)	144-10150

**Velcro strap**



**PART NR.**

L = 300mm	312-08001
-----------	-----------

**10 Set door stopper**

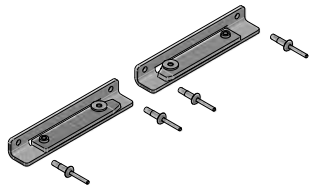

**PART NR.**

Left	144-10171
Right	144-10172

**2 Duo Penta rail (Al)**

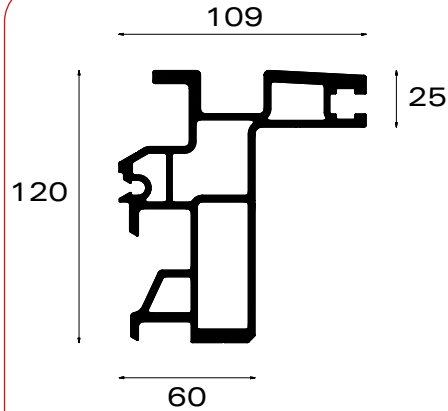

**PART NR.**

L = 5m	162-30500
L = 7,8m	162-30780
L = 8,5m	162-30850
* L = 10,5m	162-30105
* L = 13,6m	162-30136

\*profile with pre-bending

**7 Folding plate**

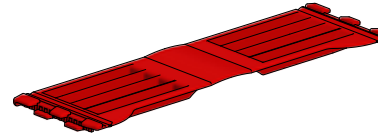

**PART NR.**

Type 400	242-01034
Type 470	242-01033
Type 500	242-01035
Type 570	242-01038
Type 600	242-01036
Type 650	242-01039

**8 Set steel insert**

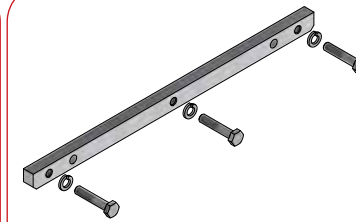

**PART NR.**

Set	144-10119
-----	-----------

**Brush seal QL door**

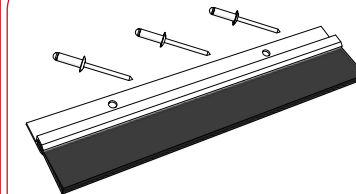

**PART NR.**

Set	144-10157
-----	-----------

**13 Set fixation curtain**

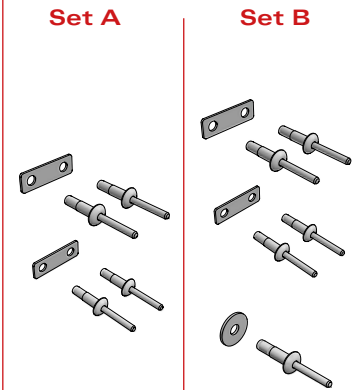

**PART NR.**

Set A	144-10144
Set B	144-10140

\*1x Set A / mini pillar  
1x Set A / basic door  
2x Set A / pillar  
1x Set B / QL-door

**12 Set mounting plates**

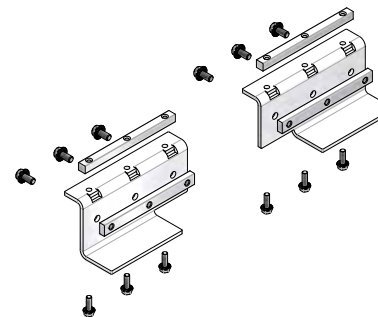

**PART NR.**

Set	154-03101
-----	-----------

**9 PVC pelmet**

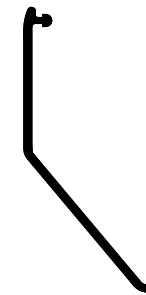

**PART NR.**

L = 9m (black)	242-12109
L = 14m (black)	242-12114



**Versus-Omega**  
Nijverheidslaan 1527a  
B-3660 Oudsbergen  
Belgium

t. +32 89 320 190  
f. +32 89 320 199  
e. [info@versus-omega.com](mailto:info@versus-omega.com)  
w. [www.versus-omega.com](http://www.versus-omega.com)

